

SCA100 Fabric Window/Door Awning Fixed Awning (No Sides) Installation Guide

It is our recommendation that you read instructions carefully prior to assembly and installation.

Width 42" x Projection 39" x Height 14"

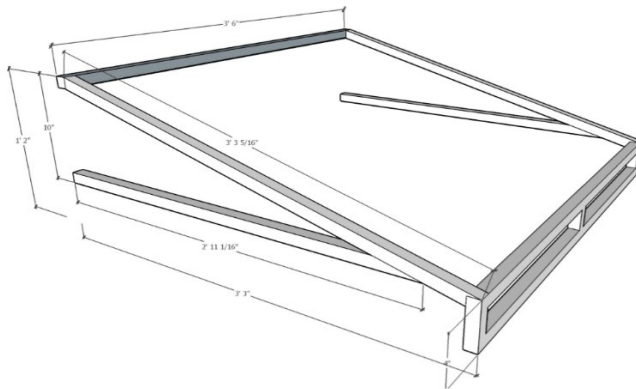

Parts Checklist:

	<input type="checkbox"/> 1/4" Washer (x4)
	<input type="checkbox"/> 2.5" Wood Screw (x4)
	<input type="checkbox"/> Z-Brackets (x2)
	<input type="checkbox"/> Self-Tapping Screw (x4)

Required Tools:



Phillips Head Screwdriver



Drill Bits



Power Drill

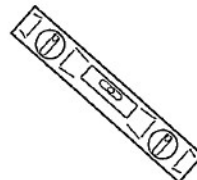



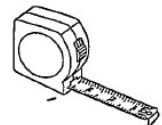



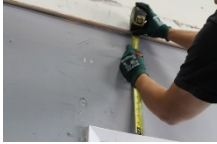

Level



Tape Measure

Awning Installation

1		<p>Make level mark 14" above door or window IMPORTANT NOTE: For outward opening doors/windows confirm height allows for door/window to clear awning.</p>
2		<p>Find studs and mark 1 3/4" below level line. This will be for the wood screw drill points for the mounting hardware (Z-Brackets).</p>
3		<p>Use 1/8" drill bit to drill pilot holes.</p>
4		<p>Assemble hardware (Z-Clip, Wood Screw, Washer) Put wood screw with washer through single hole tab on Z-Brackets.</p>
5		<p>Fasten Z-Clip into 1/8" pilot hole (leave clip slightly loose.)</p>
6		<p>Set frame into Z-Clip brackets and center over door/window</p>
7		<p>Use self-tapping screws to fasten Z-Clip directly into the frame. The two available holes in the Z-Bracket</p>
8		<p>Tighten screws that fasten Z-Clip to wall (refer to step #5)</p>
9		<p>Align lower arms to wall and fasten with wood screws & washers.</p>